



Edited with the trial version of
Foxit Advanced PDF Editor
To remove this notice, visit:
www.foxitsoftware.com/shopping

KAWSAR



کوارٹر

PVC FITTINGS

Quality, Durability Reliability For Life Time

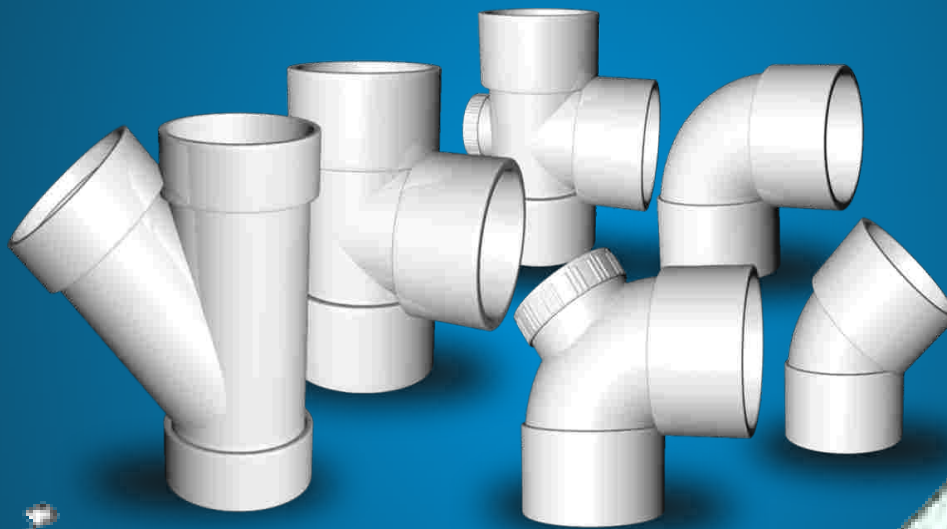

Manufactures According To



DIN



KAWSAR



کوثر

PVC FITTINGS

Quality, Durability Reliability For Life Time



<http://www.kawsar.com.af>, +93799748377

TABLE OF CONTENTS

Introduction	4
Quality Policy	5
Why Kawsar?	6
Kawsar PVC Fittings are suitable for	7
Fittings Specifications	8 - 11
Kawsar PVC Fabricated Fittings	12
Advantages of PVC Fabricated Fittings	13
PVC Fabricated Long Radius Bends & Elbows	14
PVC Fabricated long Radius Bends (Elbows) to Nema Tc9	15
Fabricated Couplers	16
Special Thanks to	17
Fittings Availability	18

KAWSAR



PVC FITTINGS

Quality, Durability Reliability For Life Time



<http://www.kawsar.com.af>, +93799748377

INTRODUCTION

Kawsar has established in 1994 as a manufacturer for water Hand Pumps. Kawsar started its regular production of plastic Polyvinyl Chloride PVC Pressure and non-Pressure pipe system for cold and potable water and other industrial uses from March 2004. After Achievement in PVC Kawsar Now Started PPR-C, HDPE pipes & Fitting with Advance Technology. We aim to set standards in every field we enter. Customer focus, quality and innovation are reflected in every aspect of our business. Our strength lies in pre-empting customer expectations and product demands. KAWSAR today is a hallmark of trust and reliability. This is why KAWSAR employs are highly skilled and experienced labor, KAWSAR utilizes the most advanced technology on its production line and retains the modern management system.

As a group, we have commitment to high ethical business values, quality of products, committed deliveries and competitive pricing. These are the factor which has taken us to the path of success achieving great heights and we are confident to achieve further heights in the times to come with the new setup. Kawsar has highly qualified staff and has experienced staff about `12 year .

We believe that our strength lies in delighting our customers. That is why, providing quality products backed by superior technical support services, is the KAWSAR promise to all our valued customers.

Besides its unique place in the Pakistan plastic and Hand Pumps industry, KAWSAR products are being exported to various other countries.

CERTIFICATIONS

In our quest to lead by example, our joint efforts have led KAWSAR to ISO 9001:2000 Certification and accreditation for supreme product performance and quality by the Pakistan Standard Institute (PSI) and Pakistan Engineering Council.



CERTIFIED COMPANY



Manufactures According To International Standards



NOTE:

Dear Customer, Please do not buy any of our products without our Registered Kawsar Logo (Brand)
www.kawsar.com.af , info@kawsar.com.af Contact: +93799748377, 0202320647

KAWSAR



کوثر

PVC FITTINGS

Quality, Durability Reliability For Life Time



<http://www.kawsar.com.af>, +93799748377

Certified Company

APPROVED BY

PSI	Pakistan Standards Institution (Govt. of Pakistan)
LGRD	Local Govt. of Rural Development Dept (NWFP)
SGS	Societe General DE Surveillance
WMD	Water Management Deptt. Govt. of NWFP, Punjab
PSQCA	Pakistan Standard & Quality Control Authority
PHED	Public Health Engineering Deptt. Govt. of NWFP.
ISO	International Standards Organization
MES	Military Engineering Services
PKPWD	Pakistan Public Works Department

ENLISTED WITH

DACCAR	Danish Committee for Aid to Afghan Refugee
SCA	Swedish Committee for Afghanistan
IRC	International Rescue Committee
UNDP	United National Development Program
UNICEF	United Nations Children Emergency Fund for Pakistan and Afghanistan
ICRC	International Committee of the Red Cross
QC	Qatar Charity
QRC	Qatar Red Crescent
SRSP	Sarhad Rural Support Programme

ISO 9001-2008 / 14001:2004

KAWSAR



PVC FITTINGS

Quality, Durability Reliability For Life Time

<http://www.kawsar.com.af>, +93799748377



QUALITY POLICY

Kawsar total quality control perceptive is taken as a principal while performing the mission. Our main policy is to provide the present and future needs and demands of our customers in the most economical way and on time. In all our processes, we adopt in the principle of customer oriented understanding.

Aim for improvement full participation of our staff. In this process management, our main goal is to continuously improve our production and to respond the demands of our customers, personals and suppliers.



OUR MISSION

To increase the number of pleased and trusted customers in our sector by satisfying them from our quality.



OUR VISION

To be committed to the mission of being the symbol of trust and contentment in the plastic and fittings market, KAWSAR proceeds to this targets as being the leader in the domestic market. And being a under rental and permanent supplier in the international market.

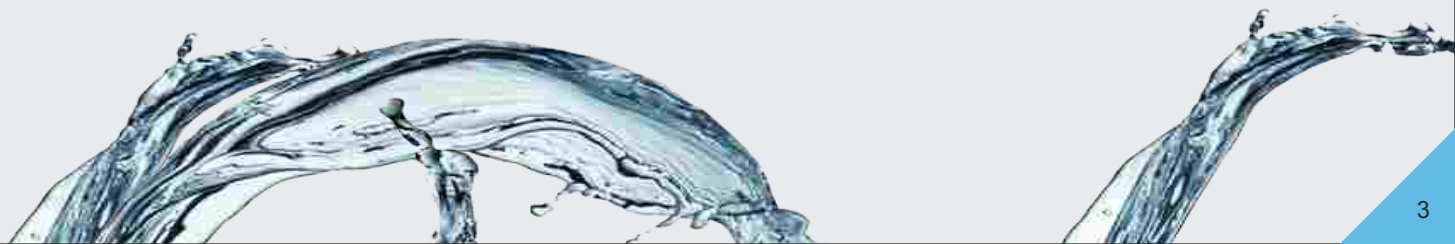

KAWSAR



PVC FITTINGS

Quality, Durability Reliability For Life Time



<http://www.kawsar.com.af>, +93799748377

WHY KAWSAR?

Being one of the best firms in the country in PVC Pipes and Fittings sector, KAWSAR gives at most importance to Quality and :

- Uses the most appropriate raw material
- Has the most advanced high technology
- Has well qualified technical staff and experienced labor
- Produces Fittings in compliance with American Standards (ASTM).
- Has well equipped laboratories which are busy round the clock to control the Quality at each stage of Production
- Fittings produced can be used not only to carry water but a wide range of fluids.

OUR NAME STANDS FOR QUALITY

Because "We never compromise on Quality"
"Quality durability for life time"



ADVANTAGES OF KAWSAR PVC FITTINGS:

KAWSAR PVC FITTINGS has got the following advantages:

- Light weight
- Easy to carry
- Easy to install
- High flow rate
- Not dangerous to Human Life, non-toxic, non cancerogeneous
- Low cost of transportation
- Non-conductor of electricity
- Fire proof, will not support combustion
- Unaffected by fungus or bacteria and its termite and weather resistant
- Has much longer service life compared to other piping systems
- Has high resistance against corrosion
- Can easily be connected to any kind of pipe. Due to low cost of Plumbing it has a wide range of applications
- Water is one of the most important compounds contributing to human life
- KAWSAR PVC PIPES & FITTINGS carry this vital fluid to your households in an easy and healthy way at a low cost.

KAWSAR



کوثر

PVC FITTINGS

Quality, Durability Reliability For Life Time



<http://www.kawsar.com.af>, +93799748377

KAWSAR ASTM D2466 PVC FITTINGS ARE SUITABLE FOR

- Irrigation
- Sewerage
- Pressure Piping
- Water treatment
- Swimming Pools
- Industrial Piping
- Foodstuff Industries
- Vent & Drain System
- Potable Water Supply
- Chemical Installation
- Compressed Air & Liquids
- KAWSAR PVC Fittings are suitable for any make of pipe made according to the international Standards.



PHYSICAL, THERMAL AND MECHANICAL PROPERTIES

1. Specific Gravity 1 .43
2. Opacity < 0.05%
3. Water Absorption 2.4 mg/cm²
4. Inflammability will not support combustion.
5. Vic at Softening Point 80 Oeg. C 2
6. Tensile strength (N/mm²) 525 kglcm
7. Elongation at Break Point 60%
8. Impact Strength (izod, Jim 120 Jim)
9. K value 58
10. Shore Hardness 80
11. Hydraulic Test up to 500 PSI

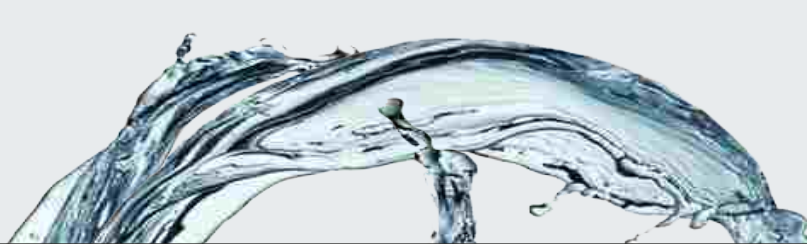



FITTINGS SPECIFICATIONS

ASTM D2466 (SCH-40)

TEE

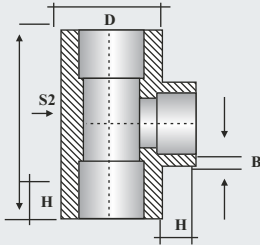

SIZE	D	L	S1	S2	H
Inch	mm	mm	mm	mm	mm
2"	69.8	148	4.3	5.2	40
3"	99.8	188	4.9	5.5	48
4"	125.9	220	5.3	5.8	50
5"	153.5	252	5.7	6.1	58
6"	181.1	338	5.8	6.2	80
8"	-	-	-	-	-

REDUCING TEE

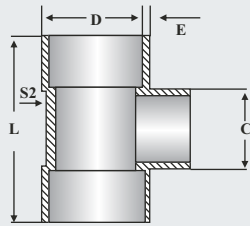

SIZE	D	l	S1	S2	d	d
Inch	mm	mm	mm	mm	mm	mm
4"x3"	125.9	200	5.3	5.8	99.8	99.8
4"x2"	125.9	172	5.3	5.8	69.8	69.8
3"x2"	99.8	166	4.9	5.5	69.8	69.8
4"x6"	181.1	282	5.8	6.2	125.9	125.9

PLUG TEE

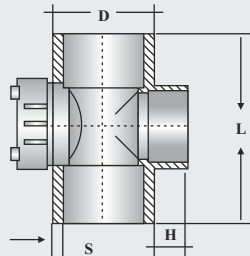

SIZE	D	L	S	H
Inch	mm	mm	mm	mm
3"	99.8	188	4.9	48
4"	125.9	220	5.3	50
5"	153.5	252	5.7	58
6"	181.1	284	6.2	80
8"	-	-	-	-

ASTM D2466 (SCH-40)





FITTINGS SPECIFICATIONS

ASTM D2466 (SCH-40)

ELBOW 90

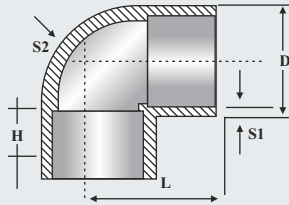

SIZE	D	L	S1	H	S2
Inch	mm	mm	mm	mm	mm
2"	69.8	74	4.3	40	5.2
3"	99.8	94	4.9	48	5.5
4"	125.8	110	5.3	50	5.8
5"	153.5	139.5	5.7	58	6.1
6"	181.1	169	5.8	80	6.2
8"	-	-	-	-	-

ELBOW 45

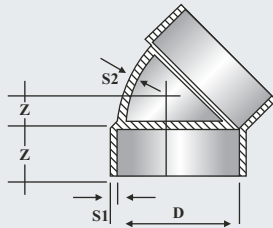

SIZE	D	Z	S1	S2	H
Inch	mm	mm	mm	mm	mm
2"	69.8	65	4.3	5.2	40
3"	99.6	68	4.9	5.5	48
4"	125.9	76	5.3	5.8	50
5"	153.5	94	5.7	6.1	58
6"	181.1	120	5.8	6.2	80
8"	-	-	-	-	-

PLUG ELBOW

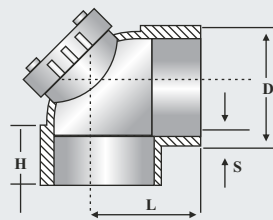

SIZE	D	L	S	H
Inch	mm	mm	mm	mm
3"	99.8	188	4.9	48
4"	125.9	220	5.3	50
5"	153.5	252	5.7	58
6"	181.1	284	6.2	80
8"	-	-	-	-

ASTM D2466 (SCH-40)



FITTINGS SPECIFICATIONS

ASTM D2466 (SCH-40)

REDUCER BUSH

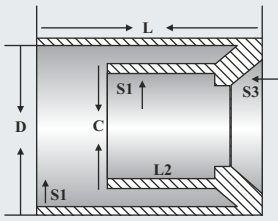

SIZE	D	L1	S1	S2	S3	d	L2
Inch	mm	mm	mm	mm	mm	mm	mm
2"x3"	89	54	4.2	4.7	4.8	69.6	40
2"x4"	114.2	57	3.8	4.2	4.2	69.6	23.4
3"x4"	114.2	57	3.8	4.1	4.5	79.6	48
4"x6"	168	80	5.1	5.8	5.8	125.4	50
8"x6"	-	-	-	-	-	-	-

Y SKEW TEE

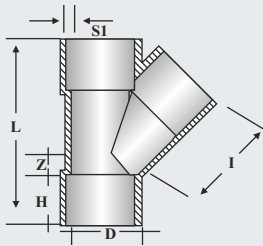

SIZE	D	L	S	H	Z	I
Inch	mm	mm	mm	mm	mm	mm
2"	69.8	176	4.3	40	16	109
3"	99.8	220	4.8	48	16	158.2
4"	125.9	165	5.3	50	23.5	215.2
6"	180.5	410.4	5.9	80	44	286.4
8"	-	-	-	-	-	-

REDUCING Y SKEW TEE

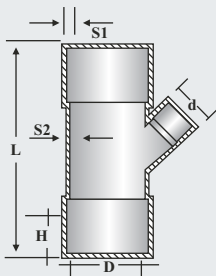

SIZE	D	L	S1	H	d	S2
Inch	mm	mm	mm	mm	mm	mm
4"x3"	125.3	336	5.8	50	99.8	6.2
6"x4"	-	-	-	-	-	-

ASTM D2466 (SCH-40)



FITTINGS SPECIFICATIONS

ASTM D2466 (SCH-40)

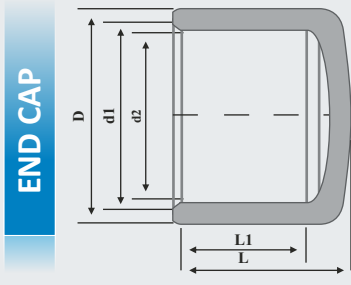

SIZE	D	D1	D2	L2	L
Inch	mm	mm	mm	mm	mm
3"	105	89.31	88.70	48	66
4"	134	114.76	114.07	57.5	76
6"	-	-	-	-	-
8"	-	-	-	-	-

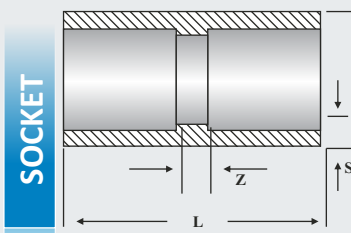

SIZE	D	L	S	Z
Inch	mm	mm	mm	mm
2"	69.6	83	4.3	3.0
3"	99.8	99	4.9	3.0
4"	125.9	104	5.3	3.0
6"	168	180	7.1	3.0
8"	-	-	-	-

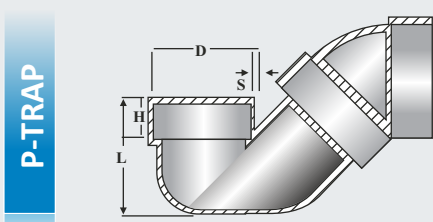

SIZE	D	L	S	H
Inch	mm	mm	mm	mm
2"	69.8	112	5.2	45
3"	99.6	126	5.5	48
4"	125.4	150	5.8	50

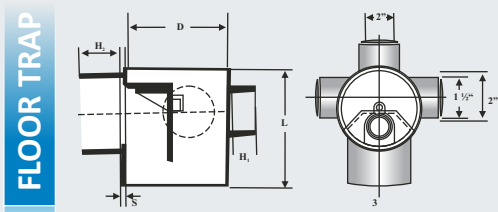

SIZE	D	L	S	H2	H1
Inch	mm	mm	mm	mm	mm
3"x2"x2"	120	116.5	3.20	51	31

ASTM D2466 (SCH-40)





KAWSAR PVC FABRICATED FITTINGS

With the ever increasing demand for PVC large size fittings from 8" to 16" costs too much. KAWSAR PVC fabricated (Weld) fittings are designed for drainage, waste & vent infrastructure system to reduce the cost. KAWSAR PVC fabricated fittings plays an important role in helping engineers and contractors to unravel in difficult situations where they couldn't find large size PVC fittings on reasonable Prices.

KAWSAR Fabricated fittings are in various sizes, angles and shapes. It could be available in different classes and sizes on demand. We have a group of experience and well train engineer welders that specializes in producing fabricated PVC fittings according to ASTM F1866 since 2004. KAWSAR produces fabricated fittings from Long Radius bends up to elbows, tees, Y-skew tees, Double Y-skew tees, cross tees, end caps and can supply a wide range of Fabricated fittings to suit our customer's requirements or project needs. This includes the standard range of fittings as listed below and specialist arrangements that are required. All KAWSAR fabricated fittings are in sizes from 8" to 16".

APPLICATIONS

1.	Acid Filling Stations	11.	Mining Operations
2.	Automotive Industry	12.	Pharmaceuticals
3.	Chemical Industry	13.	Paper Mills
4.	Cable Ducting	14.	Pickling Lines
5.	Electroplating Plants	15.	Slurry Transportation
6.	Galvanizing Plants	16.	Textile Industry
7.	Gas Transportation	17.	Thermal bath Lines
8.	Industrial Washing Lines	18.	Water Industry
9.	Irrigation	19.	Water Treatment
10.	Metallurgy Industry		

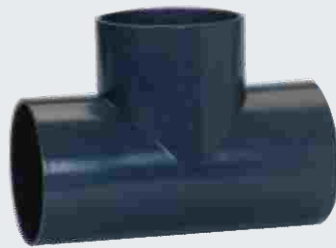



ADVANTAGES OF PVC FABRICATED FITTINGS

KAWSAR PVC Fabricated FITTINGS has got the following advantages:

- Light weight
- Low costs,
- Easy to carry
- Easy to install
- High flow rate
- Not dangerous to Human Life, non-toxic, non cancerogeneous
- Low cost of transportation
- Non-conductor of electricity
- Fire proof, will not support combustion
- Unaffected by fungus or bacteria and its termite and weather resistant
- Has much longer service life compared to other piping systems
- Has high resistance against corrosion

Can easily be connected to any kind of pipe. Due to low cost of Plumbing, it has a wide range of applications

Water is one of the most important compounds contributing to human life
 KAWSAR PVC PIPES AND FITTINGS carry this vital fluid to your households in an easy and healthy way at a low cost

Size	Elbow	Tee	Corss	Socket	Y-Skew	Double	End	Reducer
Inch			Tee		Tee	Y-Tee	Cap	Bush
6"	✓	✓	✓	✓	✓	✓	✓	6 X 4
8"	✓	✓	✓	✓	✓	✓	✓	8 X 6
10"	✓	✓	✓	✓	✓	✓	✓	10 X 8
12"	✓	✓	✓	✓	✓	✓	✓	----
14"	✓	✓	✓	✓	✓	✓	✓	----
16"	✓	✓	✓	✓	✓	✓	✓	----

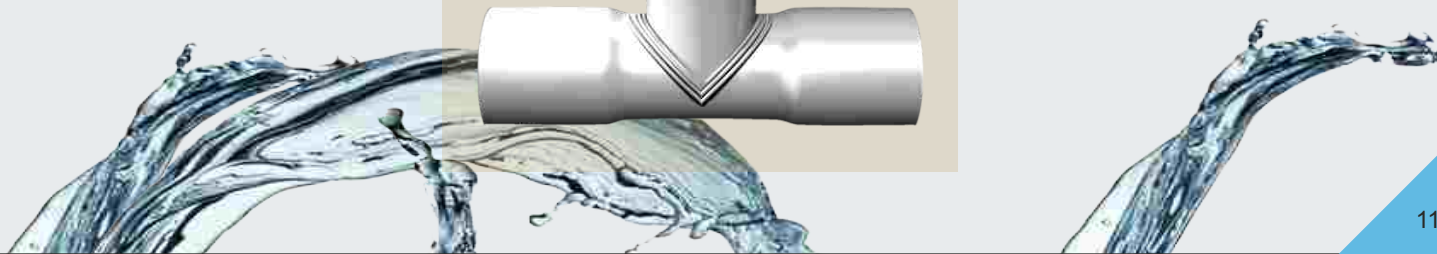



PVC FABRICATED LONG RADIUS BENDS & ELBOWS

Bends in table No.1 shall be used with ASTM-D-1785 conforming to ASTM-F-1866 and NEMA TC-2 rigid PVC conduit EPT-A, EPC-40 & EPC-80

Normal Size	Outside Dia		Radius (R)	
	Inch	mm	Inch	mm
½"	0.840	21.34	4.00	101.60
¾"	1.050	26.67	4.50	114.30
1"	1.315	33.40	5.75	146.05
1½"	1.900	48.26	8.25	208.55
2"	2.375	60.32	9.50	241.30
2½"	2.875	73.02	10.50	266.70
3"	3.500	88.90	13.00	330.20
4"	4.500	114.30	16.00	406.00
5"	5.563	141.30	24.00	609.60
6"	6.628	168.28	30.00	762.00
8"	8.625	219.08	40.00	1016.00

NOTE:
Plain ended, Single & Double Solvent weld sockets are available as per request.

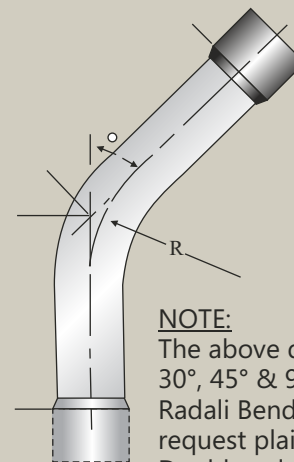
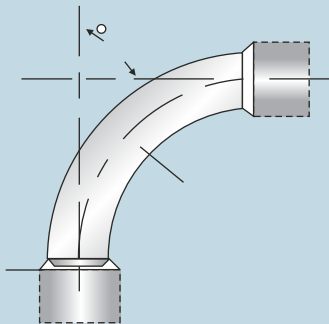

NOTE:
The above dimensions and of 30°, 45° & 90° elbows other Radali Bends are available upon request plain ended, Single & Double solvent weld sockets are available.

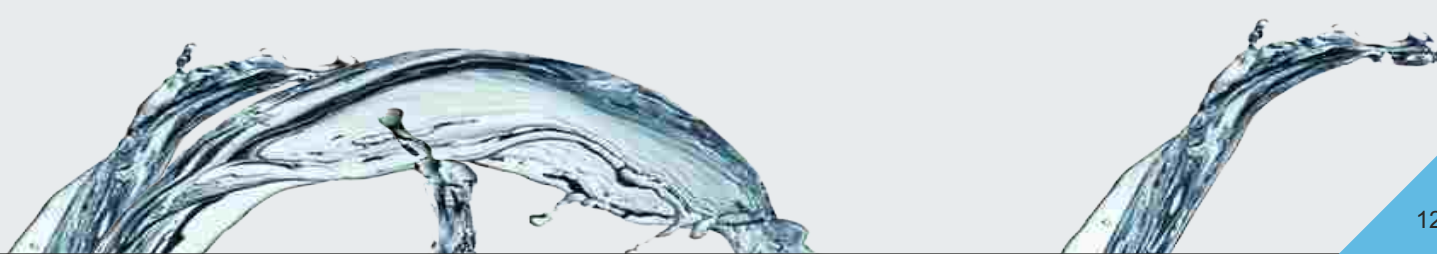



PVC Fabricated long Radius Bends (Elbows) to NEMA TC9

Bends in table no:2 shall be used with NEMA TC-6 & TC-8 rigid PVC Duets type EB and Type DB.

Table No: 2.

Normal Size of Fitting	Radii, Degrees of Curvature, and Straight Tangent Lengths at End of Bends and Sweeps							
	U.S. Customary Units				Metric			
	45° and 90° Bends, Radius	22° and 30° Bends, Radius	22° 30' 45° 90° Sweeps Radius	Minimum Straight Tangent Length at End Dimension	45° and 90° Bends, Radius	22° and 30° Bends, Radius	22° 30' 45° 90° Sweeps Radius	Mnimum Straight Tangent Length at End Dimension
Inches	Inches	Inches	Feet	Inches	Meters	Meters	Meters	Millimeters
1½	18,24,36,48	0.46,0.61,0.91,1.22	1¼	44				
2	18,24,36,48,60	18,24,35,48,60	12 ½	2	0.46,0.61,0.91, 1.22,1.52	0.46,0.61,0.91, 1.22,1.52	3.8	95.2
3	18,24,30,36,48, 60	18,24,35,48,60	12½	31/8 33/8	0.46,0.61,0.76, 0.91,1.22,1.52	0.46,0.61,0.76, 1.22,1.52	3.8	79.4
4	18,24,36,48,60		12½		0.46,0.61,0.91,	0.46,0.61,0.91,	3.8	85.7
5	36,48,60	48,60	12½	35/8	1.22,1.52	1.22,1.52	3.8	92.1
6	48,60	48,60	12½	33/4	0.91,1.22,1.52	1.22,1.52	3.8	95.2

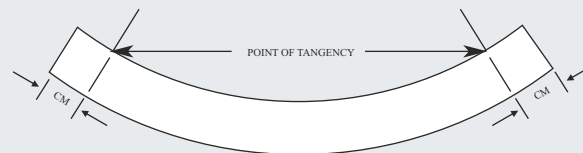

Fabricated long Radius Bends (Elbows) to 23- TMSS-OI,Rev.0

Table No: 3. Dimension for EPC-40 PVC type 45°, 90° Bends/Elbo

Trade Size (inch)	Metric Designators	C Socket Depth Max	C Socket Depth Minium	B Minimum Radius	M Minimum
¾	21	38.10	18.26	114.30	26.77
1	27	47.62	22.22	146.05	33.53
1 ¼	35	50.80	23.83	184.15	42.30
1 ½	41	50.80	26.97	209.55	48.41
2	53	50.80	28.58	241.30	60.48
2 ½	63	76.20	37.31	266.70	73.02
3	78	79.38	40.49	330.20	88.90
3 ½	91	82.55	42.85	381.00	100.71
4	103	85.73	44.45	406.40	113.41
5	129	92.08	49.20	609.60	140.80
6	155	95.25	53.96	762.00	167.84
8	200	165.10	123.83	1016.00	218.82



Bends in table no. 4 shall be used with EPC-40, PVC type conduit.

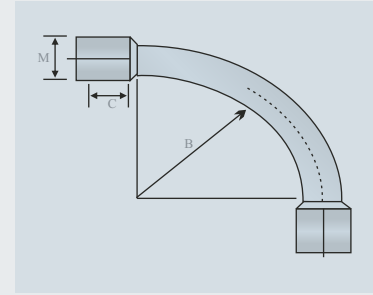

FABRICATED COUPLERS

1. Straight Couplers

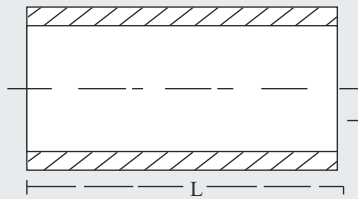

2. Register Couplers

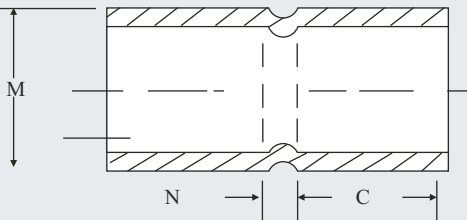
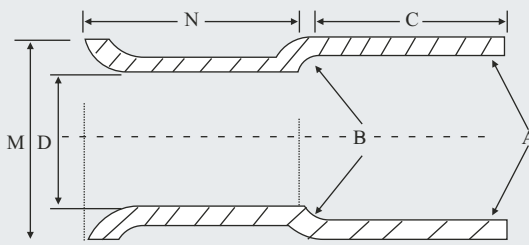

Table No. 4

Size	Dimensions for EPC-40 PVC type Couplings			Dimensions for DB and EB type Couplings		
	Socket Depth		N	Socket Depth		N
	Min	Max	Min	Min	Max	Min
3/4"	18.26	38.1	2.38	-	-	-
1"	22.22	47.62	2.38	-	-	-
1 1/4"	23.83	50.80	2.38	-	-	-
1 1/2"	26.97	50.80	2.38	-	-	-
2"	28.58	50.80	2.38	44.45	2.4	69.5
2 1/2"	37.31	76.20	4.76	-	-	-
3"	40.49	79.38	4.76	73.03	2.8	100.8
4"	44.45	85.73	4.76	85.73	2.8	127.8
6"	53.96	95.25	6.55	127.00	3.6	190.5
8"	123.83	165.10	-	-	-	-

FABRICATED BELL ENDS.



Sizes of couplings and Bell Ends ranges from 1/2", 3/4", 1 1/2", 2", 3", 4", 5", 6", 8", 10", 12", 14", 16"



KAWSAR



کوثر

PVC FITTINGS

Quality, Durability Reliability For Life Time

<http://www.kawsar.com.af>, +93799748377



FITTINGS

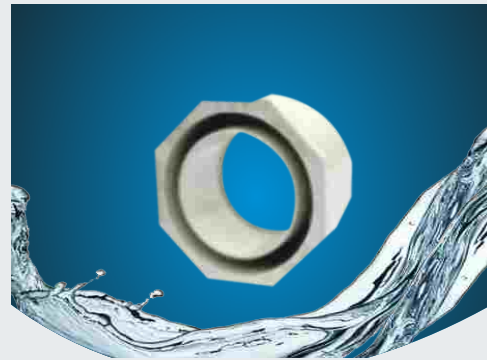
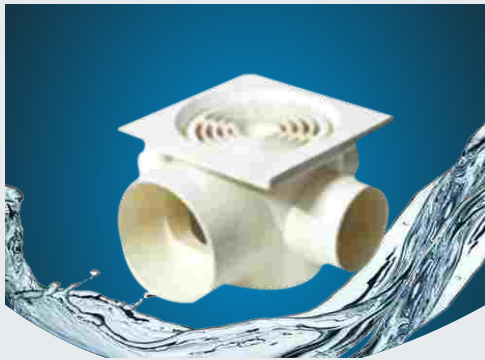



KAWSAR



HEAD OFFICE & FACTORY

Head Office: 2nd floor, Haroon Market, Between Haji Yaqub and Ansari Square, Shahmaw, Kabul Afghanistan.

Cell: (+93-202200901)-0799748377- 0799282028-0799377773

Email: info@kawsar.com.af, ceo@kawsar.com.af, kawsar.pvcpipe.af@gmail.com

Website: www.kawsar.com.af

Factory: Kabul Jalalabad road Paktia kot area end of industrial states

Tel: (+93-202320647) or (+93-0799748377) factory@kawsar.com.af

AFGHANISTAN DISTRIBUTORS

KABUL:

Shirkate-KAWSAR Pipe & AL-KAWSAR
2. Between Charahi Haji Yaqoob & Charahi Ansari
Haroon Market 2nd Floor.

Cell: 0799748377-0799282028-0777288256

info@kawsar.com.af, ceo@kawsar.com.af,

kawsar.pvcpipe.af@gmail.com

www.kawsar.com.af

MAZAR:Haji Moqim Apartment, East of Roza-e-Sharif

Phone: 05024044901

Cell: 0799212277, 0799043639, 0700501143

mazar@kawsar.com.af, mkawsar.pvcpipe@gmail.com

NANGARHAR JALALABAD

Pashtoonistan Watt Street, Gul Bahar Market, 2nd Floor,
Jalal Abad City Afghanistan.

Cell Phone: +93775343559, 0785930905, 0784475880

jalalabad@kawsar.com.af, ariana.united.brothers@gmail.com

www.kawsar.com.af

KUNDUZ CITY:

Rasta-e-Ahangiri, ShinwariMarket ,infront of Maiwand Bank

Cell:-0705951434-0773133234, kunduz@kawsar.com.af

www.kawsar.com.af

DEALERS

KUNDOZ :

Rasta-e-ahangary Shinwari Market in front of
Maiwand Bank

Cell: 0705951434, 0773133234

NINGERHAR JALALABAD:

Pashtoonistan Watt Street, Gul Bahar Market,
2nd Floor,

Jalal Abad City Afghanistan.

Cell Phone: +93775343559, 0785930905,

0784475880

jalalabad@kawsar.com.af,

ariana.united.brothers@gmail.com

Dehmazang:

Kawsar Pipe Agency Near to
Cinema Barikot

Cell: 0799616452

alkawsar.agency@gmail.com

HELMAND OFFICE:

Lashkare Gah City Jade-e-Khyber Opp.
at Haji Ubaidy Market.

Cell: 0700487141 / 0798160812

KHOAST OFFICE:

Markazi choak-e-Ijaz Market,

Khoast Bazar Cell: 0799148889

For more details about our products, Catalogs or Technical Data Sheet please visit our website

www.kawsar.com.af --- info@kawsar.com.af

NOTE:

Dear Customer, Please do not buy any of our products without our Kawsar Logo. Please try to buy / contact our registered offices/ Distributors mention on our website and Last Title back page of our catalogues for their addresses and contact Details because some people Miss use our brand name illegally. We just want to deliver you the best Quality Products with full technical support and cooperation.